

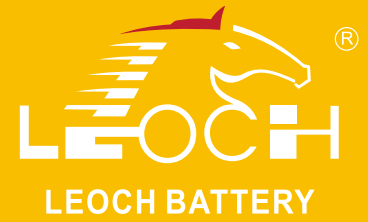

LPL Series-Long Life Standby LPL12-100(12V100Ah)



Specifications

Rated Voltage	12V	
Nominal Capacity	C ₁₀ , 1.80V/cell	100Ah
Dimension	Length	330±2mm (13.0 inches)
	Width	173±2mm (6.81 inches)
	Container Height	212±2mm (8.35 inches)
	Total Height	220±2mm (8.66 inches)
Approx Weight	30.5kg (67.2 lbs)	
Terminal	M8	
Container Material	ABS	
Rated Capacity(25°C)	105.0 Ah	C20(5.25A, 1.80V/cell)
	100.0 Ah	C10(10.0A, 1.80V/cell)
	84.5 Ah	C5(16.9A, 1.75V/cell)
	77.1 Ah	C3(25.7A, 1.75V/cell)
Max. Discharge Current	1000A (5s)	
	Internal Resistance(25°C)	
Operating Temp. Range	Discharge	-15 ~ 50°C (5 ~ 122°F)
	Charge	-20 ~ 40°C (-4 ~ 104°F)
	Storage	-15 ~ 40°C (5 ~ 104°F)
Nominal Operating Temp. Range	25±3°C (77±5°F)	
Cycle Use	Initial Charging Current less than 30A. Voltage 14.4V~15.0V at 25°C(77°F)Temp. Coefficient -30mV/°C	
	Standby Use	
Effect of temp. to Capacity	40°C (104°F)	103%
	25°C (77°F)	100%
	0°C (32°F)	86%
Self Discharge	LPL series batteries may be stored for up to 6 months at 25°C(77°F) and then a freshening charge is required. For higher temperatures the time interval will be shorter.	



Layout

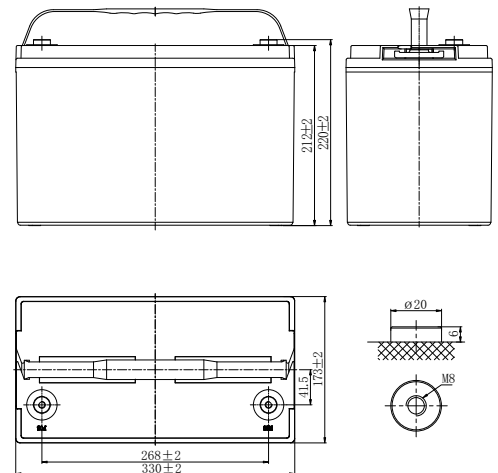

Constant Current Discharge (Amperes) at 25°C (77°F)

F.V/Time	5min	10min	15min	30min	45min	1h	1.5h	2h	3h	4h	5h	6h	8h	10h	20h
1.85V/cell	197.7	140.5	121.9	78.8	58.9	50.9	37.7	31.7	23.2	18.2	15.8	13.9	10.7	9.55	5.07
1.80V/cell	224.8	159.5	138.1	85.8	62.4	52.7	38.9	32.7	25.2	19.4	16.6	15.0	11.3	10.0	5.25
1.75V/cell	244.2	173.0	149.5	87.6	64.6	55.3	40.9	34.4	25.7	19.8	16.9	15.1	11.3	10.1	5.30
1.70V/cell	261.0	184.5	158.8	89.3	65.9	56.4	41.7	35.1	26.2	20.2	17.2	15.2	11.5	10.2	5.36
1.65V/cell	270.1	190.3	163.4	90.7	66.9	57.3	42.4	35.6	26.4	20.5	17.6	15.2	11.7	10.3	5.42
1.60V/cell	279.7	196.8	168.5	92.0	67.9	58.1	43.0	36.1	26.7	20.7	17.8	15.3	11.8	10.5	5.49

Constant Power Discharge (Watts/cell) at 25°C (77°F)

F.V/Time	5min	10min	15min	30min	45min	1h	1.5h	2h	3h	4h	5h	6h	8h	10h	20h
1.85V/cell	369.1	264.4	230.7	150.7	113.2	98.5	73.0	61.6	45.4	35.7	31.1	27.5	21.3	19.0	10.1
1.80V/cell	412.9	295.8	258.1	162.7	119.2	101.4	75.1	63.3	49.0	38.0	32.6	29.5	22.3	19.9	10.4
1.75V/cell	440.7	315.7	275.4	164.8	122.7	106.0	78.6	66.3	49.9	38.6	33.1	29.6	22.4	20.0	10.5
1.70V/cell	463.3	331.9	289.6	166.7	124.3	107.5	79.8	67.4	50.6	39.1	33.5	29.7	22.7	20.2	10.6
1.65V/cell	470.9	337.2	294.3	167.9	125.4	108.5	80.6	68.1	50.9	39.6	34.1	29.8	23.0	20.4	10.7
1.60V/cell	477.4	342.0	298.4	168.6	126.1	109.3	81.2	68.6	51.1	39.9	34.4	29.9	23.2	20.6	10.9



LPL Series-Long Life Standby LPL12-100(12V100Ah)

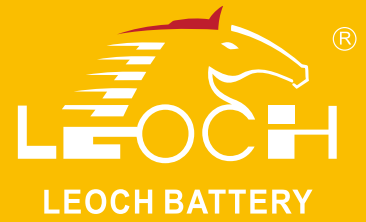

Applications

- UPS and EPS
- Emergency light
- Railway signal and aircraft signal system
- Marine and power stations
- Alarm and security system
- Electronic apparatus and equipment
- Communication power supply, DC power supply

General Features

- 12 years design life (25°C)
- Grid refining technology and the thicker plates are used to extend the battery standby life and reduce the plate grid corrosion speed
- Using oxygen recombination technology: maintenance-free
- Unique vent valve design: control water losing, prevent air and spark going inside

Standards

- Compliance with IEC 60896 standards, EU Battery Directive
- UL, CE Certified
- Manufactured in Leoch@IATF16949, ISO 45001, ISO 9001 and ISO 14001 certified production facilities

Discharge Characteristics

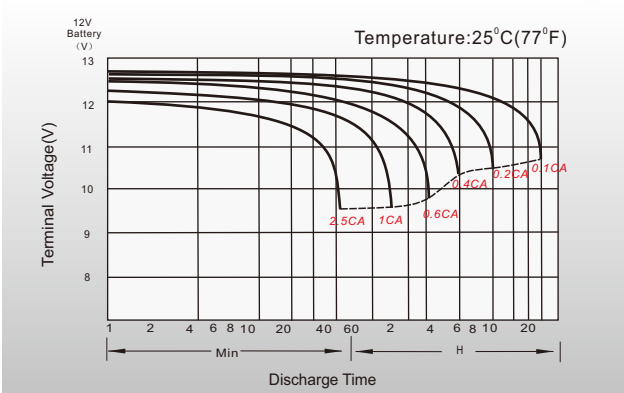

Float Charging Characteristics

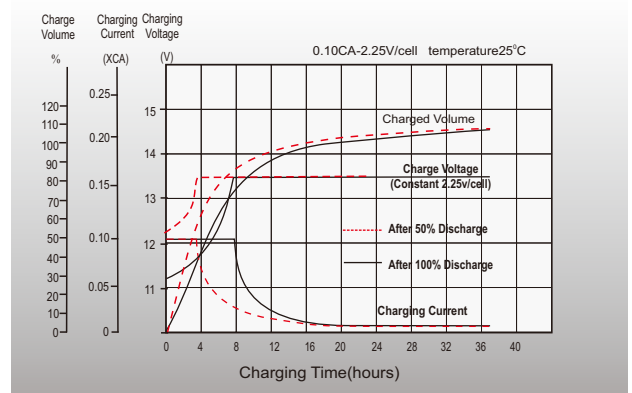

Temperature Effects in Relation to Battery Capacity

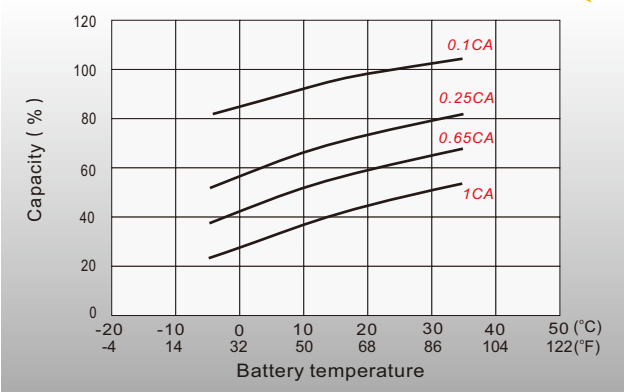

Effect of Temperature on Long Term Float Life

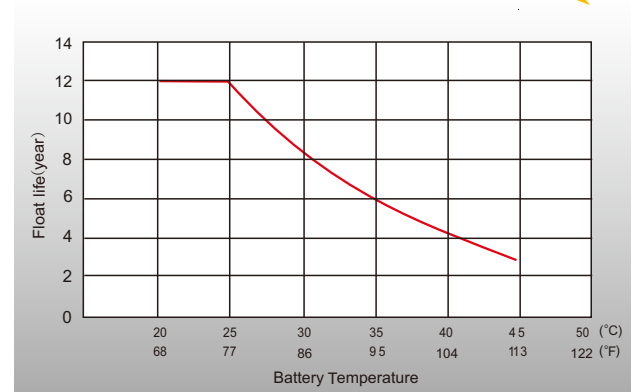

distributed by: Power Storage Deutschland GmbH

+49 (0)6081 96582-0

info@psd-power.de

www.psd-power.de



<http://www.leoch.com>

© 1999-2023 LEOCH. All rights reserved.
Trademarks and logos are the property of LEOCH and its affiliates unless otherwise noted.
Subject to revisions without prior notice E&OE.

Publication No.: LB-LPL12-100-PD-EN-V3.0-202302