

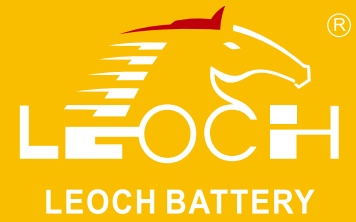

LPL Series-Long Standby Life LPL12-12(12V12Ah)



Specifications

Rated Voltage	12V	
Nominal Capacity	12.0Ah	(C ₂₀ , 1.75V/cell)
Dimension	Length	151±2mm (5.95 inches)
	Width	98±1mm (3.86 inches)
	Container Height	95±1mm (3.74 inches)
	Total Height	101±2mm (3.98 inches)
Approx Weight	3.87 Kg (8.50 lbs)	
Terminal	T1/T2	
Container Material	ABS	
Rated Capacity (25°C)	12.0 Ah	(20hr, 0.600A, 1.75V/cell)
	11.2 Ah	(10hr, 1.12A, 1.75V/cell)
	10.2 Ah	(5hr, 2.04A, 1.75V/cell)
	9.09 Ah	(3hr, 3.03A, 1.75V/cell)
	7.80 Ah	(1hr, 7.80A, 1.60V/cell)
Max. Discharge Current	180A (5s)	
Internal Resistance (25°C)	Approx 14.0mΩ	
Operating Temp. Range	Discharge	-15 ~ 50°C (5 ~ 122°F)
	Charge	-20 ~ 40°C (-4 ~ 104°F)
	Storage	-15 ~ 40°C (5 ~ 104°F)
Nominal Operating Temp. Range	25±3°C (77±5°F)	
Cycle Use	Initial Charging Current less than 3.6A. Voltage 14.4V~15.0V at 25°C(77°F)Temp. Coefficient -30mV/°C	
	Initial Charging Current less than 3.6A. Voltage 13.5V~13.8V at 25°C(77°F)Temp. Coefficient -20mV/°C	
Effect of temp. to Capacity	40°C (104°F)	103%
	25°C (77°F)	100%
	0°C (32°F)	86%
Self Discharge	LPL series batteries may be stored for up to 6 months at 25°C(77°F) and then a freshening charge is required. For higher temperatures the time interval will be shorter.	

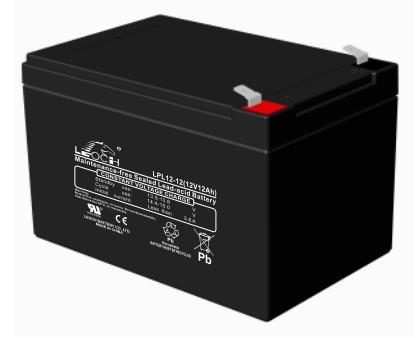

Layout

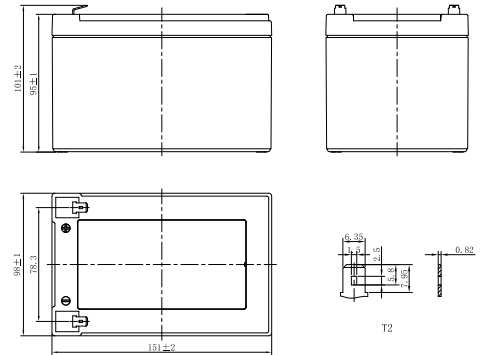

Constant Current Discharge (Amperes) at 25 °C (77°F)

F.V/Time	5min	10min	15min	20min	30min	45min	1h	1.5h	2h	3h	4h	5h	6h	8h	10h	20h
1.85V/cell	38.1	26.0	19.7	16.1	11.9	8.60	7.00	5.20	4.10	2.93	2.34	1.99	1.70	1.34	1.10	0.587
1.80V/cell	41.0	27.5	20.7	16.7	12.2	8.90	7.20	5.30	4.18	2.98	2.37	2.02	1.73	1.36	1.11	0.593
1.75V/cell	43.2	28.6	21.4	17.2	12.6	9.10	7.40	5.40	4.25	3.03	2.40	2.04	1.75	1.38	1.12	0.600
1.70V/cell	45.2	29.8	22.1	17.7	12.9	9.30	7.50	5.50	4.32	3.07	2.44	2.07	1.77	1.39	1.14	0.605
1.67V/cell	46.8	30.6	22.7	18.1	13.1	9.40	7.60	5.60	4.36	3.10	2.46	2.09	1.79	1.40	1.14	0.610
1.60V/cell	49.6	31.9	23.5	18.6	13.5	9.60	7.80	5.70	4.45	3.16	2.50	2.12	1.81	1.42	1.16	0.616

Constant Power Discharge (Watts/cell) at 25 °C (77°F)

F.V/Time	5min	10min	15min	20min	30min	45min	1h	1.5h	2h	3h	4h	5h	6h	8h	10h	20h
1.85V/cell	72.1	49.4	37.8	31.0	22.9	16.8	13.7	10.1	8.03	5.77	4.61	3.93	3.37	2.66	2.18	1.17
1.80V/cell	76.8	52.0	39.4	32.0	23.6	17.1	14.0	10.3	8.16	5.85	4.67	3.98	3.42	2.70	2.21	1.19
1.75V/cell	80.0	53.7	40.5	32.8	24.0	17.5	14.2	10.5	8.28	5.93	4.72	4.03	3.45	2.73	2.23	1.20
1.70V/cell	83.0	55.5	41.6	33.5	24.5	17.8	14.4	10.6	8.38	6.01	4.78	4.08	3.49	2.75	2.25	1.21
1.67V/cell	85.1	56.7	42.5	34.1	24.9	18.0	14.6	10.7	8.46	6.06	4.82	4.10	3.52	2.77	2.27	1.22
1.60V/cell	88.6	58.4	43.7	35.0	25.5	18.3	14.9	10.9	8.60	6.15	4.89	4.16	3.56	2.81	2.29	1.23



LPL Series-Long Standby Life

LPL12-12(12V12Ah)

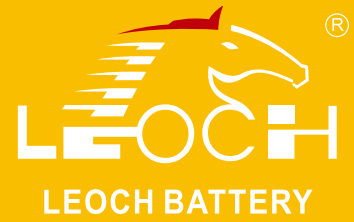

Applications

- UPS and EPS
- Emergency light
- Railway signal and aircraft signal system
- Marine and power stations
- Alarm and security system
- Electronic apparatus and equipment
- Communication power supply, DC power supply

General Features

- 10 ~ 12 years design life(20°C)
- Grid refining technology and the thicker plates are used to extend the battery standby life and reduce the plate grid corrosion speed
- Using oxygen recombination technology: maintenance-free
- Unique vent valve design: control water losing, prevent air and spark going inside

Standards

- Compliance with IEC 60896 standards, EU Battery Directive
- UL, CE Certified
- Manufactured in Leoch@IATF16949, OHSAS 18001, ISO 9001 and ISO 14001 certified production facilities

Discharge Characteristics

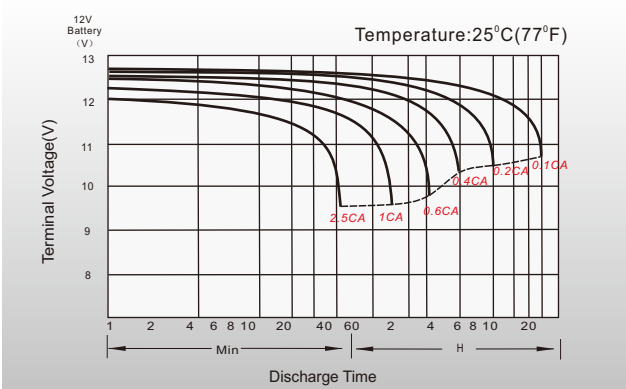

Float Charging Characteristics

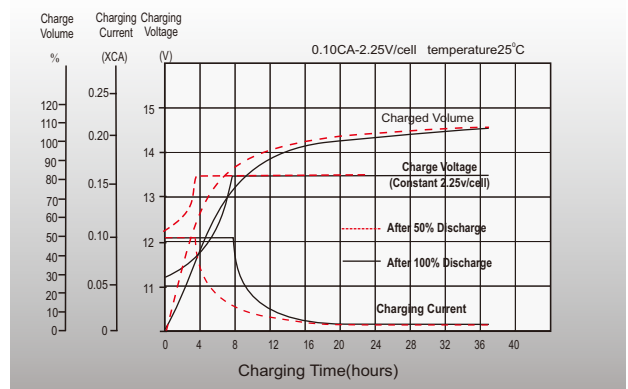

Temperature Effects in Relation to Battery Capacity

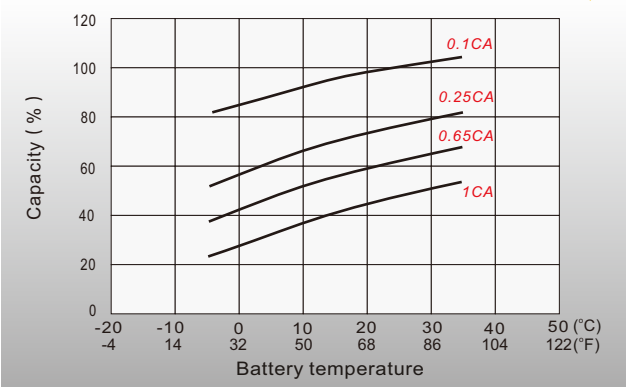

Float Service Life

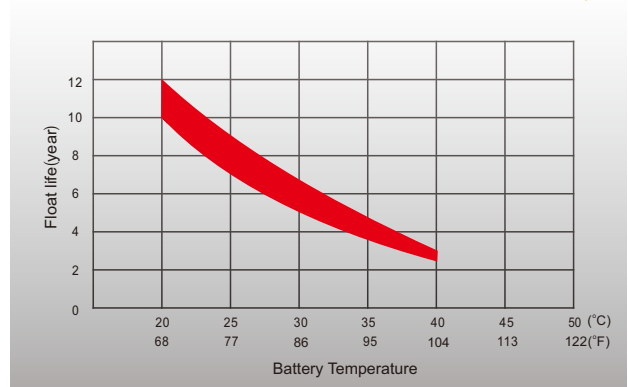

distributed by: Power Storage Deutschland GmbH

+49 (0)6081 96582-0

info@psd-power.de

www.psd-power.de



[Http://www.leoch.com](http://www.leoch.com)

© 2022 LEOCH. All rights reserved.
Trademarks and logos are the property of LEOCH and its affiliates unless otherwise noted.
Subject to revisions without prior notice.

Publication No.: LB-LPL-12-PD-EN-V3.0-202211