

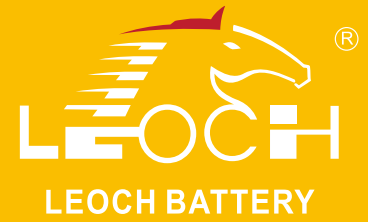

# LPL Series-Long Life Standby LPL12-250(12V250Ah)



## Specifications

Rated Voltage	12V	
Nominal Capacity	$C_{10}, 1.80V/cell$	250Ah
Dimension	Length	522±2mm (20.6 inches)
	Width	268±2mm (10.6 inches)
	Container Height	220±2mm (8.66 inches)
	Total Height	226±2mm (8.90 inches)
Approx Weight	76.5kg (168.7 lbs)	
Terminal	M8	
Container Material	ABS	
Rated Capacity(25°C)	262.0 Ah	C20(13.1A, 1.80V/cell)
	250.0 Ah	C10(25.0A, 1.80V/cell)
	212.0 Ah	C5(42.4A, 1.75V/cell)
	193.2 Ah	C3(64.4A, 1.75V/cell)
	148.6 Ah	C1(148.6A, 1.60V/cell)
Max. Discharge Current	2500A (5s)	
Internal Resistance(25°C)	Approx 2.7mΩ	
Operating Temp. Range	Discharge	-15 ~ 50°C (5 ~ 122°F)
	Charge	-20 ~ 40°C (-4 ~ 104°F)
	Storage	-15 ~ 40°C (5 ~ 104°F)
Nominal Operating Temp. Range	25±3°C (77±5°F)	
Cycle Use	Initial Charging Current less than 75 A. Voltage 14.4V~15.0V at 25°C(77°F)Temp. Coefficient -30mV/°C	
Standby Use	Initial Charging Current less than 75 A. Voltage 13.5V~13.8V at 25°C(77°F)Temp. Coefficient -20mV/°C	
Effect of temp. to Capacity	40°C (104°F)	103%
	25°C (77°F)	100%
	0°C (32°F)	86%
Self Discharge	LPL series batteries may be stored for up to 6 months at 25°C(77°F) and then a freshening charge is required. For higher temperatures the time interval will be shorter.	



## Layout

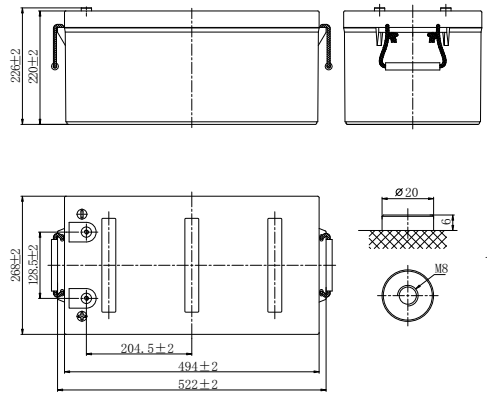

## Constant Current Discharge (Amperes) at 25°C (77°F)

F.V/Time	5min	10min	15min	30min	45min	1h	1.5h	2h	3h	4h	5h	6h	8h	10h	20h
1.85V/cell	494.1	351.4	304.6	210.1	153.7	130.2	94.3	79.3	58.2	45.6	39.6	34.9	26.9	23.9	12.7
1.80V/cell	562.0	398.8	345.2	228.8	162.8	134.8	97.6	81.9	63.1	48.7	41.7	37.5	28.3	25.0	13.1
1.75V/cell	610.4	432.5	373.7	233.5	168.7	141.5	102.5	86.2	64.4	49.6	42.4	37.8	28.4	25.3	13.3
1.70V/cell	652.6	461.2	396.9	238.1	172.1	144.3	104.6	87.9	65.6	50.5	43.1	38.0	28.8	25.5	13.4
1.65V/cell	675.3	475.7	408.5	241.6	174.6	146.4	106.1	89.2	66.2	51.3	44.0	38.2	29.2	25.8	13.6
1.60V/cell	699.2	492.0	421.2	245.1	177.1	148.6	107.7	90.5	66.9	51.9	44.6	38.4	29.6	26.1	13.7

## Constant Power Discharge (Watts/cell) at 25°C (77°F)

F.V/Time	5min	10min	15min	30min	45min	1h	1.5h	2h	3h	4h	5h	6h	8h	10h	20h
1.85V/cell	922.9	661.0	576.8	377.5	283.7	246.7	183.0	154.3	113.7	89.5	78.0	69.0	53.3	47.5	25.2
1.80V/cell	1032.3	739.4	645.2	407.7	298.6	254.2	188.2	158.5	122.8	95.2	81.7	73.8	55.9	49.6	26.1
1.75V/cell	1101.8	789.2	688.6	412.9	307.5	265.5	197.0	166.2	124.9	96.7	82.9	74.2	56.1	50.1	26.3
1.70V/cell	1158.3	829.6	723.9	417.6	311.5	269.4	200.0	168.8	126.8	98.0	84.0	74.4	56.9	50.5	26.6
1.65V/cell	1177.1	843.1	735.7	420.6	314.3	271.8	202.0	170.6	127.5	99.2	85.4	74.6	57.5	51.1	26.9
1.60V/cell	1193.6	854.9	746.0	422.4	315.9	273.8	203.5	172.0	128.0	99.9	86.3	74.9	58.1	51.6	27.1



# LPL Series-Long Life Standby LPL12-250(12V250Ah)

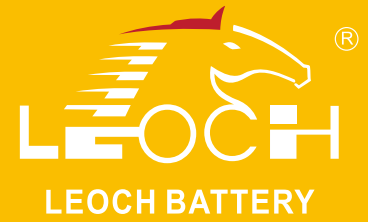

## Applications

- UPS and EPS
- Emergency light
- Railway signal and aircraft signal system
- Marine and power stations
- Alarm and security system
- Electronic apparatus and equipment
- Communication power supply, DC power supply

## General Features

- 12 years design life (25°C)
- Grid refining technology and the thicker plates are used to extend the battery standby life and reduce the plate grid corrosion speed
- Using oxygen recombination technology: maintenance-free
- Unique vent valve design: control water losing, prevent air and spark going inside

## Standards

- Compliance with IEC 60896 standards, EU Battery Directive
- UL, CE Certified
- Manufactured in Leoch@IATF16949, ISO 45001, ISO 9001 and ISO 14001 certified production facilities

## Discharge Characteristics

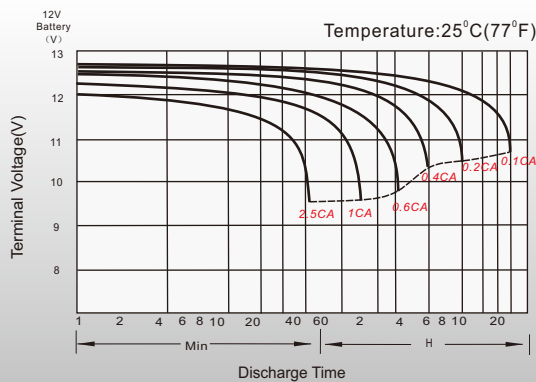

## Float Charging Characteristics

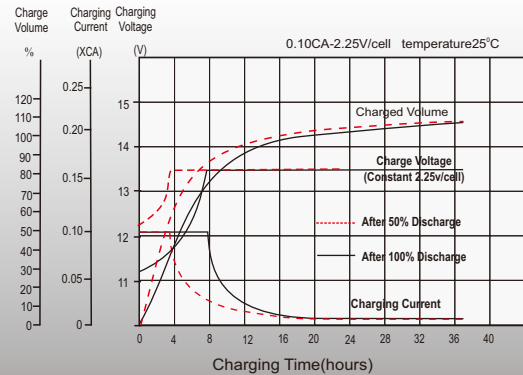

## Temperature Effects in Relation to Battery Capacity

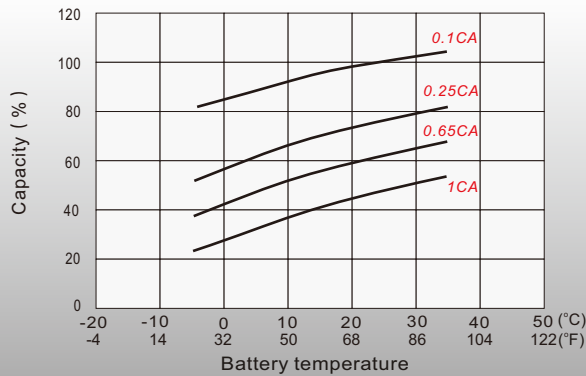

## Effect of Temperature on Long Term Float Life

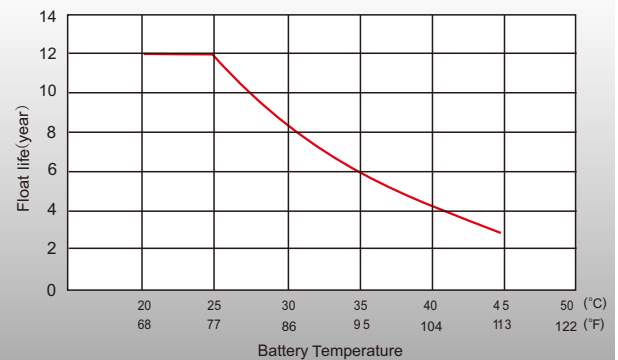

distributed by: Power Storage Deutschland GmbH

+49 (0)6081 96582-0

info@psd-power.de

www.psd-power.de



<http://www.leoch.com>

© 1999-2023 LEOCH. All rights reserved.  
Trademarks and logos are the property of LEOCH and its affiliates unless otherwise noted.  
Subject to revisions without prior notice E&OE.

Publication No.: LB-LPL12-250-PD-EN-V3.0-202302